



Jaw Type Couplings—USA Standard Elastomer-in-Compression

The Jaw Type couplings from Lovejoy are offered in the industry's largest variety of stock bore/keyway combinations. These couplings require no lubrication and provide highly reliable service for light, medium, and heavy duty electrical motor and internal combustion power transmission applications. Other features and benefits include:

- Fail-safe — will still perform if elastomer fails.
- No metal to metal contact.
- Resistant to oil, dirt, sand, moisture and grease.
- More than 850,000 combinations of bore sizes.
- Most types available from stock in 24 hours.

Applications include power transmission to industrial equipment such as pumps, gear boxes, compressors, blowers, mixers, and conveyors. Lovejoy's Jaw Type couplings are available in 24 sizes from a minimum torque rating of 3.5 in-lbs to a maximum torque rating of 170,004 in-lbs and a bore range of .125 inches to 7 inches. Lovejoy's standard bore program covers AGMA, SAE, and DIN bore/keyway and spline bore combinations.

The Lovejoy Jaw Type coupling is available in a variety of metal hub and insert materials. Hubs are offered in sintered metal, aluminum, bronze, steel, stainless steel, and ductile iron.

L Type

This coupling offers standard shaft-to-shaft connection for general industrial duty applications. Standard L type coupling hub materials are either sintered iron (L035 - L150) or cast iron (L190 - L276).

LC Type

This is the basic L coupling, except the insert is a snap wrap elastomer with retaining collar. Designed for easy elastomer replacement without disturbing the hubs, this coupling type is suited for applications over 1750 RPM.

AL Type

The aluminum construction means this coupling is light weight with low overhung load and low inertia. The AL type also offers excellent resistance to atmospheric conditions, so it is perfect for corrosive environment applications.

SS Type

New SS type stainless steel hubs available for applications needing maximum protection against harsh environmental conditions. Sizes SS075-SS150 available from stock. Other sizes available on request.

RRS Type

The center "drop out" section of this coupling provides proper shaft separation while also allowing easy elastomer installation without disturbing the hubs or requiring realignment of shafts. Designed for the pump industry, it accommodates American and European industry standard pump/motor shaft separations. The drop out spacer is made of glass reinforced plastic, cast iron or aluminum.

SW Type

This coupling is the standard L Type with a snap wrap elastomer with retaining ring. It is well suited for standard shaft-to-shaft connection in general industrial purpose applications under 1750 RPM.

C & H Types

These couplings provide standard shaft-to-shaft connection for medium (C) and heavy (H) duty range applications. The standard C coupling hub is made of cast iron, while the H is constructed of ductile iron.



L COUPLING



LC COUPLING



AL COUPLING



SS COUPLING



RRS COUPLING



SW COUPLING



C & H COUPLINGS

The new Jaw In-Shear coupling is presented in the next section of this catalog, labeled "JIS" on the page tabs

Elastomers-in-Compression

Lovejoy offers four types of elastomer designs to allow for additional flexibility in addressing specific application requirements. One piece designs are used in the “L” and “AL” models (referred to as spiders) and multiple part “load cushions” are used in the “C” and “H” model couplings. The load cushions are in sets of 6 to 14 pieces depending on coupling size.

Solid Center Spider

The solid center design is the most commonly used in general power transmission applications when the shafts of the driver and driven can be kept separate by a standard gap.

Open Center Spider

The open center spider design allows the shafts of the driver and driven to be positioned within a short distance. Open center spiders offer shaft positioning flexibility but have a lower maximum RPM capability. (1750 RPM max. for NBR, 3600 RPM max. for Urethane/Hytrel.)

Cushions

The cushion design is available exclusively for the Lovejoy Types C and H jaw couplings. The load cushions are held in place radially by a steel collar which is attached to one of the hubs. This design allows for easy installation and removal of the load cushions. The cushion design has the same engineering purpose as the spider designs but is more effective in the heavy duty applications that Types C and H couplings address.

Snap Wrap Flexible Spider

The snap wrap flexible spider design allows the spider section of the coupling to be easily installed or removed without disturbing the coupling hubs. This design also allows for close shaft separations all the way up to the hubs maximum bore, which is not possible with open center spiders. Maximum RPM is 1750 with retaining ring, but if used in LC Type (with collar) the normal RPM rating of the coupling size applies. This style is available in NBR and Urethane only, and in limited sizes.

NOTE:

Complete technical data for the new Jaw In-Shear elastomer is contained in the next section of this catalog, labeled “JIS” on the page tabs.



Spider Materials

SOX (NBR) Rubber

Nitrile Butadiene (Buna N) Rubber, a highly flexible insert material that is oil resistant, is our standard elastomer. It resembles natural rubber in resilience and elasticity, and operates effectively in temperature ranges of -40° to +212° F (-40° to +100°C). (Also applies to SXB Cushions.)

Urethane

Urethane has 1.5 times greater torque capability than NBR and offers good resistance to oil and chemicals. However, this material provides less dampening effect and operates at a temperature range of -30° to +160° F (-34° to +71°C).

Hytrel

Hytrel is a flexible elastomer designed for high torque and high temperature operations. Hytrel can operate in temperatures of -60° to +250° F (-51° to +121°C) and has an excellent resistance to oil and chemicals. It is best used in continuous load applications rather than cyclic or on/off service.

Bronze

Bronze is a rigid, porous, oil-impregnated metal insert exclusively for low speed (max. 250 RPM) applications requiring high torque capabilities. Bronze performance is not affected by water, oil, dirt, or extreme temperatures — operates in temperatures of -40° to +450° F (-40° to +232° C).



WARNING

You must refer to page iv for Important Safety Instructions and Precautions for the selection and use of these products. Failure to follow the instructions and precautions can result in severe injury or death.

Jaw Type Coupling Selection Process

The selection process for determining the proper jaw coupling size and elastomer requires using the charts shown on the following pages. There are three components to be selected, two hubs and one elastomer. When the shaft size of the driver and driven of the application are of the same diameter, the hubs selected will be the same. When shaft diameters differ, hubs selected will differ accordingly.

Information necessary before a coupling can be selected:

- HP (or KW) and RPM or Torque of driver
- Shaft sizes of driver and driven equipment and corresponding keyways
- Application description
- Environmental conditions (i.e. extreme temperature, corrosive conditions, space limitations)

List of Charts provided for Selection:

Chart 1—Application Service Factors (pg. JW-6)

Chart 2—Spider Performance Data (pg. JW-7)

Chart 3—Coupling Nominal Rated Torque (pg. JW-7 or JW-20)

Formulas:

$$\text{Nominal Torque} = \text{in-lb} = \frac{(\text{HP} \times 63025)}{\text{RPM}}$$

$$\text{Nm} = \frac{(\text{KW} \times 9550)}{\text{RPM}}$$

$$\text{Design Torque} = \text{Nominal Torque} \times \text{Application Service Factor}$$

Steps In Selecting A Jaw Coupling

Step 1: Determine the Nominal Torque of your application by using the following formula:

$$\text{Nominal Torque} = \text{in-lb} = \frac{(\text{HP} \times 63025)}{\text{RPM}}$$

$$\text{Nm} = \frac{(\text{KW} \times 9550)}{\text{RPM}}$$

Step 2: Using the Application Service Factors Chart 1 (pg. JW-6) select the service factor which best corresponds to your application.

Step 3: Calculate the Design Torque of your application by multiplying the Nominal Torque calculated in Step 1 by the Application Service Factor determined in Step 2.

$$\text{Design Torque} = \text{Nominal Torque} \times \text{Application Service Factor}$$

Step 4: Using the Spider Performance Data Chart 2 (pg. JW-7), select the elastomer material which best corresponds to your application.

Step 5: Using the Coupling Nominal Rated Torque Chart 3 (pg. JW-7), locate the appropriate elastomer material column for the elastomer selected in Step 4.

Scan down this column to the first entry where the Torque Value in the appropriate column is greater than or equal to the Design Torque calculated in Step 3.

Once this value is located, refer to the corresponding coupling size in the first column of the Coupling Nominal Rated Torque Chart 3 (pg. JW-7).

Refer to the maximum RPM value (pg. JW-20) for this elastomer torque capability to ensure that the application requirements are met. If the requirement is not satisfied at this point, another type of coupling may be required for the application. Please consult our Lovejoy application engineers.

Step 6: Compare the application driver/driven shaft sizes to the maximum bore size available on the coupling selected. If coupling bore size is not large enough for the shaft diameter, select the next largest coupling that will accommodate the driver/driven shaft diameters. Refer to Chart 3 (pg. JW-7).

Step 7: Using the Item (UPC) Number Selection charts (pgs. JW-9 and JW-10), find the appropriate Bore and Keyway sizes required and locate the Lovejoy Item (UPC) number.

Selection Example

A coupling is needed to connect a 20 HP standard electric motor rated at 1800 RPM to a rotary pump. The shaft size of the electric motor (driver) is 2.0 inches and the pump (driven) is 1.75 inches. There are no special environmental conditions and the general operating temperature is normal room temperature of 72° F. Less than 1° of misalignment is expected.

Step 1: Determine the Nominal Torque:

$$\begin{aligned} \text{Nominal Torque} &= \frac{(\text{HP} \times 63025)}{\text{RPM}} \\ &= \frac{(20 \times 63025)}{1800} \\ &= 700.28 \text{ in-lb} \end{aligned}$$

Step 2: Using the Application Service Factor Chart 1 (pg. JW-6), select the service factor which best corresponds to your application. The Application Service Factor for an electric motor with standard torque driving a rotary pump is 1.25. The value of 1.25 is found under the application category Pumps, Rotary, column: Electric Motor w/Standard Torque in Chart 1.

Step 3: Calculate the Design Torque of your application:

$$\begin{aligned} \text{Design Torque} &= \text{Nominal Torque} \times \text{Application Service Factor} \\ &= 700.28 \times 1.25 \\ &= 875.35 \text{ in-lb} \end{aligned}$$

Step 4: Using the Elastomer Performance Data Chart 2 (pg. JW-7), select the elastomer material which best corresponds to your application. Since there are no special environmental conditions, the operating temperature is 72°F and less than 1° of angular misalignment is required, the NBR elastomer material is selected.

Step 5: Using the Coupling Nominal Rated Torque Chart 3 (pg. JW-7), the NBR elastomer column is used to determine the proper coupling size. Scanning down the NBR column, the first entry to accommodate the Design Torque value of 875.35 in-lb is the size L150 with a nominal torque rating of 1,240 in-lb. Referring to page JW-20, the maximum RPM of 1800 on the electric motor of the application does not exceed the 5000 RPM maximum allowed for the L150 size coupling with an NBR elastomer.

Step 6: Compare the application driver/driven shaft size to the maximum bore available in the coupling selected (pg. JW-7). The electric motor (driver) of this application has a shaft size of 2.0 inches and the pump (driven) has a shaft size of 1.75 inches. The L150 coupling has a maximum bore less than the driver shaft size. Continuing down the Maximum Bore column, in Chart 3 (pg. JW-7), the L190 size is found to have a maximum bore size of 2.125 and is able to accommodate the driver/driven

shaft sizes.

Therefore, the proper coupling size for this application is a Lovejoy L190 with an NBR elastomer.

Step 7: Using the Item (UPC) number Selection charts, locate the appropriate Lovejoy Item (UPC) numbers. The L Type Coupling Elastomer chart (pg. JW-8), and the L Type Coupling Inch Hubs chart (pg. JW-10), provides easy reference to the Lovejoy Item (UPC) numbers.

Locate the L Type Couplings Elastomer chart (pg. JW-8).

The elastomer is selected by scanning down the type column and locating the NBR (Solid) entry. Read across to the L190 column and locate the Lovejoy Item (UPC) number of 12274. This number should be prefixed with the Lovejoy Item (UPC) number of 685144.

Locate the L Type Coupling Inch Hubs selection chart (pg. JW-10).

The first bore size to be located is for the 2 inch shaft on the electric motor. Scan down the Bore/Keyway column to the 2 inch bore entry. Read across to the L190 column to locate the Lovejoy Item (UPC) number of 12303. This number should be prefixed with the Lovejoy Item (UPC) number of 685144.

The second bore size to be located is for the 1.75 inch shaft on the pump. Scan down the Bore/Keyway column to the 1³/₄ inch bore entry. Read across to the L190 column to locate the Lovejoy Item (UPC) number of 12299. This number should be prefixed with the Lovejoy Item (UPC) number of 685144.

Application Service Factors

Chart 1

	Service Factors						Service Factors						Service Factors				
	Electric Motor w/ Standard Torque	Electric Motor w/ High Torque	Steam Turbines & En- gines w/4 or more cyl.*	Reciprocating Engines*			Electric Motor w/ Standard Torque	Electric Motor w/ High Torque	Steam Turbines & En- gines w/4 or more cyl.*	Reciprocating Engines*			Electric Motor w/ Standard Torque	Electric Motor w/ High Torque	Steam Turbines & En- gines w/4 or more cyl.*	Reciprocating Engines*	
				1- Cyl.	2- Cyl.					1- Cyl.	2- Cyl.					1- Cyl.	2- Cyl.
Agitators	1.00	1.25	1.00	1.7	1.3	Feeders						Beater, Pulper,					
Band Resaw (lumber) ..	1.50	1.75	1.50	2.2	1.8	Belt, Screw	1.00	1.25	1.00	1.7	1.3	Jordans, Dresses	2.00	2.25	2.00	2.7	2.3
Barge Haul Puller	2.00	2.25	2.00	2.7	2.3	Reciprocating	2.50	2.75	2.50	3.2	2.8	Calenders, Dryers, Washers,					
Beaters	1.50	1.75	1.50	2.2	1.8	Filter, Press-oil	1.50	1.75	1.50	2.2	1.8	Thickener	1.50	1.75	1.50	2.2	1.8
Blowers						Generators						Converting Machines,					
Centrifugal	1.00	1.25	1.00	1.7	1.3	Not Welding	1.00	1.25	1.00	1.7	1.3	Conveyors	1.20	1.45	1.20	1.9	1.5
Lobe, Vane	1.25	1.50	1.25	2.0	1.6	Welding.....	2.00	2.25	2.00	2.7	2.3	Printing Presses	1.50	1.75	1.50	1.7	1.3
Bottling Machinery	1.25	1.50	1.25	2.0	1.6	Hoist	1.50	1.75	1.50	2.2	1.8	Pug Mill	1.75	2.00	1.75	2.0	1.6
Brew Kettles (distilling)	1.25	1.50	1.25	2.0	1.6	Hammermills	2.00	2.25	2.00	2.7	2.3	Pumps					
Can Filling Machinery	1.00	1.25	1.00	1.7	1.3	Kilns	1.50	1.75	1.50	2.2	1.8	Centrifugal	1.00	1.25	1.00	1.7	1.3
Car Dumpers	2.50	2.75	2.50	3.2	2.8	Laundry Washers—						Gear, Rotary, Vane	1.25	1.50	1.25	2.0	1.6
Car Pullers	1.50	1.75	1.50	2.2	1.8	Reversing	2.00	2.25	2.00	2.7	2.3	Reciprocating:					
Card Machine	1.75	2.00	1.75	2.5	2.0	Lumber Machinery						1-Cyl. Single or					
Chiller (oil)	1.50	2.00	1.25	2.0	2.0	Barkers, Edger Feeder,						Double Acting	2.00	2.25	2.00	2.7	2.3
Compressors						Live Roll	2.00	2.25	2.00	2.7	2.3	2-Cyl. Single Acting ..	2.00	2.25	2.00	2.7	2.3
Centrifugal	1.00	1.25	1.00	1.7	1.3	Planer, Slab Conveyor ..	2.00	2.25	2.00	2.7	2.3	2-Cyl. Double Acting	1.75	2.00	1.75	2.5	2.0
Screw, Lobe	1.25	1.50	1.25	2.0	1.6	Machine Tools						3 or more Cyl.	1.50	1.75	1.50	2.2	1.8
Reciprocating					See Note	Punch Press-gear Driven,						Rubber Machinery					
Conveyors, Uniformly Fed						Plate Planer.....	2.00	2.25	2.00	2.7	2.3	Mixers.....	2.50	2.75	2.50	3.2	2.8
Assembly, Belt, Screw	1.00	1.25	1.00	1.7	1.3	Tapping Machinery,						Rubber Calender	2.00	2.25	2.00	2.7	2.3
Bucket, Sawdust.....	1.25	1.50	1.25	2.0	1.6	Bending Roll	2.00	2.25	2.00	2.7	2.3	Screens					
Live Roll, Shaker,						Main Drive	1.50	1.75	1.50	2.2	1.8	Air washing, Water	1.00	1.25	1.00	1.7	1.3
.....Reciprocating	3.00	3.25	3.00	3.7	3.3	Auxiliary Drives.....	1.00	1.25	1.00	1.7	1.3	Rotary—stone or gravel,					
Conveyors, Not Uniformly Fed						Metal Forming Machines						Dewatering	1.50	1.75	1.50	2.2	1.8
Assembly, Belt,						Draw Bench-carriage						Vibrating	2.50	2.75	2.50	3.2	2.8
.....Oven, Screw	1.20	1.45	1.20	1.9	1.5	& Main Drive	2.00	2.25	2.00	2.7	2.3	Grizzly	2.00	2.25	2.00	2.7	2.3
Reciprocating	2.50	2.75	2.50	3.2	2.8	Extruder, Forming Machine,						Shredders	1.50	1.75	1.50	2.2	1.8
Shaker	3.00	3.25	3.00	3.7	3.3	Wire Drawing.....	2.00	2.25	2.00	2.7	2.3	Steering Gears	1.00	1.25	1.00	1.7	1.3
Cookers—Brewing, Distilling,						Table Conveyors.....	2.50	2.75	2.50	3.2	2.8	Stokers	1.00	1.25	1.00	1.7	1.3
Food	1.25	1.50	1.25	2.0	1.6	Wire Winding, Coilers,						Suction Roll (paper) ..	1.50	1.75	1.50	2.2	1.8
Cranes & Hoist	2.00	2.25	2.00	2.7	2.3	Slitters	1.50	1.75	1.50	2.2	1.8	Textile Machinery					
Crushers—Cane (sugar), Stone, or Ore						Mills, Rotary Type						Dryers, Dyeing Machinery,					
.....	3.00	3.25	3.00	3.7	3.3	Ball, Kilns, Pebble,						Mangle	1.20	1.45	1.20	2.0	1.6
Dredges						Rolling, Tube	2.00	2.25	2.00	2.7	2.3	Loom, Spinner,					
Cable reels	2.00	2.25	2.00	2.7	2.3	Cement Kilns,						Tenter frames.....	1.50	1.75	1.50	2.2	1.8
Conveyors, Pumps,						Dryers, Coolers	2.00	2.25	2.00	2.7	2.3	Tumbling Barrels	1.75	2.00	1.75	2.5	2.0
Maneuvering Winches	1.50	1.75	1.50	2.2	1.8	Tumbling	1.50	1.75	1.50	2.2	1.8	Windlass	2.00	2.25	2.00	2.7	2.3
Cutter Head Drives....	2.50	2.75	2.50	3.2	2.8	Mixers						Woodworking Mach.	1.00	1.25	1.00	1.7	1.3
Dynamometer	1.50	1.75	1.50	2.2	1.8	Concrete, continuous..	1.75	2.00	1.75	2.5	2.0						
Evaporators	1.00	1.25	1.00	1.7	1.3	Muller	1.50	1.75	1.50	2.2	1.8						
Fans						Paper Mills											
Centrifugal	1.00	1.25	1.00	1.7	1.3	Agitator (mixers),											
Cooling Towers	2.00	2.25	2.00	2.7	2.3	Reel, Winder	1.20	1.45	1.20	1.9	1.5						
Forced Draft,						Winder	1.20	1.45	1.20	1.9	1.5						
Propeller	1.50	1.75	1.50	2.2	1.8	Barker (mechanical),											
Induced draft						Log Haul, Chipper	2.00	2.25	2.00	2.7	2.3						
w/damper control.....	2.00	2.25	2.00	2.7	2.3	Barking Drum											
Induced draft w/o						(spur gear).....	2.50	2.75	2.50	3.2	2.8						
damper control	1.25	1.50	1.25	2.0	1.6												

Caution: Applications involving reciprocating engines and reciprocating driven devices are subject to critical rotational speeds which may damage the coupling and/or connected equipment. Contact Lovejoy Engineering with specific requirements.

Spider Performance Data

Chart 2

Characteristics	Temperature Range	Misalignment		Shore Hardness ¹	Dampening Capacity	Chemical Resistance ²	Color
		Angular Degree	Parallel Inch				
SOX (NBR) Rubber—Nitrile Butadiene (Buna N) Rubber is a flexible elastomer material that is oil resistant, resembles natural rubber in resilience and elasticity and operates effectively in temperature range of -40 to +212°F (-40 to +100°C). Good resistance to oil. Standard elastomer. (Also applies to SXB Cushions.)	-40° to +212° F -40° to +100° C	1°	.015	80A	HIGH	GOOD	BLACK
URETHANE—Urethane has greater torque capability than NBR (1.5 times), provides less dampening effect, and operates at a temperature range of -30 to +160°F (-34 to +71°C). Good resistance to oil and chemicals. Not recommended for cyclic or start/stop applications.	-30° to +160° F -34° to +71° C	1°	.015	55D L050-L110 90-95A L150-L225	LOW	VERY GOOD	BLUE
HYTREL—Hytrel is a flexible elastomer designed for high torque and high temperature operations. Hytrel can operate in temperatures of -60F to +250°F (-51 to+121°C) and has an excellent resistance to oil and chemicals. Not recommended for cyclic or start/stop applications.	-60° to +250° F -51° to 121° C	1/2°	.015	55D	LOW	EXCELLENT	TAN
BRONZE—Bronze is a rigid, porous oil-impregnated metal insert exclusively for slow speed (maximum 250 RPM) applications requiring high torque capabilities. Bronze operations are not affected by extreme temperatures, water, oil, or dirt.	-40° to +450° F -40° to +232° C	1/2°	.010	NONE	EXCELLENT	BRONZE

Notes: 1. NBR standard shore hardness is 80A ±5A—Except L035=60A. Other softer or harder designs are available in NBR material; consult Lovejoy.
2. Chemical Resistance chart shown in Engineering Data section.

Coupling Nominal Rated Torque

Chart 3

Size	Maximum Bore		Spider Material							
	Inch	mm	SOX(NBR) Torque		Urethane Torque		Hytrel Torque		Bronze Torque	
			in-lbs	Nm	in-lbs	Nm	in-lbs	Nm	in-lbs	Nm
L035	.375	9	3.5	0.4	N/A	N/A	N/A	N/A	N/A	N/A
L/AL050	.625	16	26.3	3.0	39	4.5	50	5.6	50	5.6
L/AL070	.750	19	43.2	4.9	65	7.3	114	12.9	114	12.9
L/AL075	.875	22	90.0	10.2	135	15.3	227	25.6	227	25.6
L/AL090	1.000	25	144.0	16.3	216	24.4	401	45.3	401	45.3
L/AL095	1.125	28	194.0	21.9	291	32.9	561	63.4	561	63.4
L/AL099	1.188	30	318.0	35.9	477	53.9	792	89.5	792	89.5
L/AL100	1.375	35	417.0	47.1	626	70.7	1134	128.0	1134	128.0
L/AL110	1.625	42	792.0	89.5	1188	134.0	2268	256.0	2268	256.0
L150	1.875	48	1240.0	140.0	1860	210.0	3708	419.0	3706	419.0
AL150	1.875	48	1450.0	163.8	N/A	N/A	N/A	N/A	N/A	N/A
L190	2.125	55	1728.0	195.0	2592	293.0	4680	529.0	4680	529.0
L225	2.625	65	2340.0	264.0	3510	397.0	6228	704.0	6228	704.0
L276	2.875	73	4716.0	533.0	N/A	N/A	N/A	N/A	12500	1412.0
C226	2.500	64	2988.0	338.0	N/A	N/A	5940	671.0	5940	671.0
C276	2.875	73	4716.0	533.0	N/A	N/A	9432	1066.0	N/A	N/A
C280	3.000	76	7560.0	854.0	N/A	N/A	13866	1567.0	N/A	N/A
C285	4.000	102	9182.0	1038.0	N/A	N/A	16680	1882.0	N/A	N/A
C295	3.500	89	11340.0	1281.0	N/A	N/A	22680	2563.0	22680	2563.0
C2955	4.000	102	18900.0	2136.0	N/A	N/A	37800	4271.0	37800	4271.0
H3067	4.500	114	33395.0	3774.0	N/A	N/A	47196	5333.0	47196	5333.0
H3567	5.000	127	46632.0	5269.0	N/A	N/A	63000	7119.0	63000	7119.0
H3667	5.629	143	64812.0	7323.0	N/A	N/A	88200	9966.0	88200	9966.0
H4067	6.250	159	88224.0	9969.0	N/A	N/A	126000	14237.0	126000	14237.0
H4567	7.000	178	119700.0	13525.0	N/A	N/A	170004	19209.0	170000	19209.0

Note: Bronze has a maximum RPM capability of 250 RPM. N/A indicates not available.

L Type Coupling

The L Type sizes range from L035 to L276. Ordering requires selecting Item (UPC) numbers for two standard L hubs and one standard open or solid center elastomer (spider).

SW Type Coupling

The SW Type sizes range from L090 to L190. Ordering requires selecting Item (UPC) numbers for two standard L hubs and one snap wrap spider. For both L and SW Type couplings, select hubs from the Standard Bore and Keyway chart (pgs. JW-9 and JW-10). Max. RPM for SW + Ring is 1750 RPM. LC coupling types must be used for speeds above 1750 RPM. The LC Type coupling uses a snap wrap spider with a collar instead of a retaining ring.



Jaw In-Shear Coupling

Ordering requires selecting item numbers for two standard hubs, one In-Shear elastomer and one In-Shear ring. See pages JIS-1 through JIS-4.

L Type Coupling Spiders

When referencing the Lovejoy Item (UPC) number, include 685144 as a prefix to the number shown in the table below.

Type	L035	L050	L070	L075	L090/095	L099/100	L110	L150	L190	L225	L276
SOX(NBR) (Solid)	10118	10194	10406	10621	11070	11494	11724	12001	12274	12409
SOX(NBR) (open center)	10393	10620	10968	11492	11711	37880	37881	12406	12612
Urethane (Solid)	37786	10395
Urethane (open center)	10411	10626	11075	11499	11729	12006	12280	12417
Hytrel (Solid)	25307	11717	11993	12265	12401
Hytrel (open center)	25308	25309	25310	11486	38097	38098	38099	12400
Bronze (open center)	10198	10409	10624	11073	11497	11727	12004	12277	34517	25767
Snap Wrap (NBR) w/ring	24669	24670	24671	24672	24673
Snap Wrap (NBR) w/o ring	11071	11495	11725	12002	12275
SOX (NBR) Bulk - pk 25	50115	50116	50117	50118	50119
SOX (NBR) Bulk - pk 10	50120	50121	50122
Snap Wrap Urethane - solid ring	41170	41171	28284	26093
In-Shear Elastomer	67576	67577	67578	67579	67580	68559	67581
In-Shear Ring	67584	67585	67586	67587	67588	68560	67589

L Type Hub Spline Bore Chart

When referencing the Lovejoy Item (UPC) number, include 685144 as a prefix to the number shown in the table below.

Teeth	Pitch	SAE	Spline Bore Diameters		Major Diam.	L090	L095	L099	L100	L110	L150	L190	L225	L276
			Major	Minor										
9	16/32	A	.651	.509	.625	38568	37900	38571	37904
11	16/32		.776	.631	.750	38569	37901	38572	37905	37909	37917	37925
13	16/32	B	.901	.754	.875	38570	37902	38573	37906	37910	37918	37926	37935
13	8/16	D, E	1.798	1.506	1.750	37915	37923	37931	37940	38576
14	12/24	C	1.289	1.087	1.250	37912	37920	37928	37937	38577
15	16/32	BB	1.026	.877	1.000	38574	37907	37911	37919	37927	37936	38578
21	16/32		1.401	1.250	1.375	37913	37921	37929	37938
23	16/32		1.526	1.375	1.500	37914	37922	37930	37939
27	16/32		1.776	1.625	1.750	37916	37924	37932	37941	38579
15	8/16	F	2.048	1.753	2.000	37933	37942

- Notes:**
1. All pressure angles on above splines = 30°. Class 5 fit is standard, unless otherwise specified.
 2. All stock spline bore hubs are supplied standard with Lovejoy's exclusive Centaloc Spline Locking Feature. See page C-21 for description.

L Type Metric Hubs

Standard Bore and Keyway Chart

When referencing the Lovejoy Item (UPC) number, include 685144 as a prefix to the number shown in the table below.



JW

Bore	Keyway	L035	L050	L070	L075	L090	L095	L099	L100	L110	L150	L190	L225	L276
4	No KW	41850
5	No KW	47419	46214
6	No KW	45872	50351
7	No KW	60679	10215	58803
8	No KW	55169	41460	46151	60945
9	3 x 1.4	41313	56177	44298
10	No KW	10216	41452	41456
10	3 x 1.4	41450	49870	41457	52828
11	4 x 1.8	41314	41453	50811	49424
12	No KW	48510	51562	48276
12	4 x 1.8	41315	41454	44153	44329	44832	55195
14	No KW	58036	47505	41461	41465
14	5 x 2.3	41316	41317	41321	51231	41466	60094	45101
15	No KW	60708	10693	46561	52697	41469
15	5 x 2.3	41451	41455	41458	52096	45778	46972	47123
16	5 x 2.3	56176	41318	41322	49198	41325	52098	55534	52092	52471
17	5 x 2.3	45333	49398	49704	56178	60067	60156
18	6 x 2.8	59724	41884	46433	46626	44647	41926	44288
19	No KW	10777	41471
19	6 x 2.8	41319	41323	41462	41326	44157	41329	49700	48821	46717
20	6 x 2.8	41459	41925	41467	47122	52093	41804	61218	61497
22	6 x 2.8	58246	41968	44827	41959	44467	45214	44720
24	8 x 3.3	41463	41327	41990	41330	48301	48182	59109
25	8 x 3.3	41464	41468	45055	41470	41906	46751	52153
28	No KW	56179	56182
28	8 x 3.3	41328	50103	41331	41333	45679	52976
30	8 x 3.3	47132	48317	45681	41738	44471	48982
32	No KW	41472	41473	48319	56232
32	10 x 3.3	41332	41334	41873	45562	41849	41885
35	No KW	56180	56183	56184
35	10 x 3.3	49925	45682	46562	58035	52197
38	10 x 3.3	41335	41337	41474	49664	52961
40	12 x 3.3	45683	48318	48320	49605	59308
42	12 x 3.3	41336	41338	41475	47492	45609
45	14 x 3.8	45102	56017	52674	50292
48	No KW	56181
48	14 x 3.8	56227	48322	47569	61202
50	No KW	56228	56230	56233
50	14 x 3.8	44392	48797	45062
55	No KW	56229	56231	56234
55	16 x 4.3	47006	44089	56067
60	No KW	56185	56235
60	18 x 4.4	44598	56236
65	No KW	56237
65	18 x 4.4	56544	50102
70	20 x 4.9	58268

Notes: 1. Tolerances for bore and keyways are found in Engineering Data section (pg. 14). All hubs supplied standard with one set screw.
 2. Non-standard bores available—consult Lovejoy Engineering.

L Type Inch Hubs

Standard Bore and Keyway Chart

When referencing the Lovejoy Item (UPC) number, include 685144 as a prefix to the number shown in the table below.



Bore inch	Keyway	L035	L050	L070	L075	L090	L095	L099	L100	L110	L150	L190	L225	L276
1/8	No KW	10124
3/16	No KW	10126
1/4	No KW	10127	10206	10416	10680	10766
1/4	1/8 x 1/16	35744
5/16	No KW	10128	10207	10417	10681	26209
3/8	No KW	24687	10208	10418	10682	10767
3/8	3/32 x 3/64	46121	41985	37234	37235
3/8	1/8 x 1/16	44136	48829	35745	37236
7/16	No KW	10209	10419	10683	10768	11082	31297	11505
7/16	3/32 x 3/64	44713	44007	28089	28877	27613	38198	37237
7/16	1/8 x 1/16	44066	28875	28878	28879	38199	37238
1/2	No KW	10210	10420	10684	10769	11083	11333	11506
1/2	1/8 x 1/16	10211	10421	10685	26087	26088	11334	26089
9/16	No KW	10212	52338	10686	24976	37239	11335	11508
9/16	1/8 x 1/16	10213	10423	10687	28876	11084	38200	11509
5/8	No KW	10214	24771	44322	46052	41911	44174	44291	11733	12101
5/8	5/32 x 5/64	51104	37240	37241	37242	38201	37243	37244	37245
5/8	3/16 x 3/32	10424	10688	10771	11085	11336	11510	26211	26212
11/16	3/16 x 3/32	10425	10689	10772	11086	11337	11511	11734	12102
3/4	No KW	46116	56140	54282	56887	49705	45212	12285	12422
3/4	1/8 x 1/16	51719	35881	37246	37074	38202	37247	37248	37249	37250
3/4	3/16 x 3/32	10426	10690	10773	11087	11338	11512	11735	12103	38468	35882
13/16	3/16 x 3/32	10691	10774	11088	11339	11513	11736	12104	37252	37255
7/8	No KW	56941	59063	12582
7/8	3/16 x 3/32	10692	10775	11089	11340	11514	11737	12105	12286	12423	12585
7/8	1/4 x 1/8	38188	35747	38203	35686	35749	35750	37256	35753	54883
15/16	1/4 x 1/8	32332	11090	11341	11515	11738	12106	12287	12424
1	1/4 x 1/8	31296	11091	11342	11516	11739	12107	12288	12425	12586
1	3/16 x 3/32	37257	37258	38204	37259	37260	37261	37262	37263
11/16	1/4 x 1/8	11092	11343	11517	11740	12108	12289	12426
11/16	1/4 x 1/8	11093	11344	11518	11741	12109	12290	12427	12587
13/16	1/4 x 1/8	11345	11519	11742	12110	12291	12428
11/4	1/4 x 1/8	11520	11743	12111	12292	12429	12588
11/4	5/16 x 5/32	35748	35752	35751	37264	35754	12589
15/16	5/16 x 5/32	11521	11744	12112	12293	26090
13/8	5/16 x 5/32	11522	11745	12113	12294	12430	12590
13/8	3/8 x 3/16	44348	37265	37266	37267	37268	46758
17/16	3/8 x 3/16	11746	12114	12295	12431	12591
11/2	5/16 x 5/32	37269	37270	37271	37272
11/2	3/8 x 3/16	11747	12115	12296	12432	12592
19/16	3/8 x 3/16	11748	12116	37273	12433	45689
15/8	3/8 x 3/16	11749	12117	12297	12434	12593
111/16	3/8 x 3/16	12118	12298	12435	60057
13/4	3/8 x 3/16	12119	12299	12436	12594
13/4	7/16 x 7/32	37274	37275	37276	48250
113/16	1/2 x 1/4	12120	12300	26091
17/8	1/2 x 1/4	12121	12301	12437	12595
115/16	1/2 x 1/4	12302	12438	49762
2	1/2 x 1/4	12303	12439	12596
21/16	1/2 x 1/4	12304	26092
21/8	1/2 x 1/4	12305	12440	12597
23/16	1/2 x 1/4	12441	12598
21/4	1/2 x 1/4	12442	12599
23/8	5/8 x 5/16	12443	12602
25/8	5/8 x 5/16	41809	12605
27/8	3/4 x 3/8	12607

Notes: 1. Tolerances for bore and keyways are found in Engineering Data section (pg. 16). All hubs supplied standard with one set screw.

JW-10 2. Non-standard bores available—consult Lovejoy Engineering.

LC Type Couplings

LC Type couplings range in size from LC090 to LC225. The coupling design provides for a collar to be attached to our hub shielding the snap wrap spider. Ordering requires selecting Item (UPC) numbers for one standard L Type hub (without collar attachment), (pgs. JW-9, JW-10), one LC Type hub (provides collar attachment), one standard snap wrap center insert and one collar with screws.



Snap Wrap Spider and Collar Chart

When referencing the Lovejoy Item(UPC) number, include 685144 as a prefix to the number shown in the table below.

	LC090	LC095	LC099	LC100	LC110	LC150	LC190	LC225
Snap Wrap Spider/No Ring	11071	11071	11495	11495	11725	12002	12275	26093*
Collar Only w/Screws	48340	48340	45258	45258	47932	47933	47934	47935

Note: *indicates L225 snap wrap spider is urethane, solid ring.

LC Type Metric Hubs

Standard Bore and Keyway Chart

When referencing the Lovejoy Item (UPC) number, include 685144 as a prefix to the number shown in the table below.

Bore mm	Keyway mm	LC090	LC095	LC099	LC100	LC110	LC150	LC190	LC225
8	No KW
9	3 x 1.4
10	No KW
10	3 x 1.4
11	4 x 1.8
12	No KW	58596
12	4 x 1.8	58597
14	No KW	58598	58592
14	5 x 2.3	58556	58559
15	No KW
15	5 x 2.3	58599
16	5 x 2.3	58593
17	5 x 2.3
19	No KW
19	6 x 2.8	58557	58560	56197	58563	58566
20	6 x 2.8	58594
22	6 x 2.8
24	8 x 3.3	58558	58561	58588	58564	58567
25	8 x 3.3	58600	58595	58589
28	No KW
28	8 x 3.3	58562	58590	58565	58568	58571	58575
30	8 x 3.3
32	No KW
32	10 x 3.3	52806	58587	58585	58586
35	No KW
35	10 x 3.3
38	10 x 3.3	58569	58572	58576	58580
40	12 x 3.3
42	12 x 3.3	58570	58573	58577	58581
45	14 x 3.8
48	No KW
48	14 x 3.8	58574	58578	58582
50	No KW
50	14 x 3.8
55	No KW
55	16 x 4.3	58579	58583
60	No KW
60	18 x 4.4
65	No KW	58584
65	18 x 4.4

Notes:

1. These "LC" hubs are drilled and tapped to accept collar mounting screws but the collar and hardware are not included.
2. See L Type (inch or metric) coupling hub chart for standard hub (pgs. JW-9 and JW-10).
3. Tolerances for bore and keyways are found in Engineering Data section (pg. 15).
4. All hubs are supplied with one set screw.

LC Type Couplings

Ordering requires selecting Item (UPC) numbers for one standard L Type hub (without collar attachment), (pgs. JW-9, JW-10), one LC Type hub (provides collar attachment), one standard snap wrap center insert, (pg. JW-11), and one collar with screws, (pg. JW-11).



LC Type Inch Hubs

Standard Bore and Keyway Chart

When referencing the Lovejoy Item (UPC) number, include 685144 as a prefix to the number shown in the table below.

Bore	Keyway	LC090	LC095	LC099	LC100	LC110	LC150	LC190	LC225
1/4	No KW	45321
3/8	No KW	45322
1/2	No KW	45323	11133
1/2	1/8 x 1/16	11575
5/8	No KW	48768	11828
5/8	5/32 x 5/64	45412
5/8	3/16 x 3/32	45324	11134	48886
3/4	No KW	11577	12322	12456
3/4	1/8 x 1/16
3/4	3/16 x 3/32	45325	11135	55466	11829	12323
13/16	3/16 x 3/32	11136	41920	11830
7/8	3/16 x 3/32	45326	11137	11832
7/8	1/4 x 1/8	56567	11578	56566
15/16	1/4 x 1/8	11138	49553	11834	60343
1	1/4 x 1/8	45327	11139	52825	11836	44161	50125
1	3/16 x 3/32	11579	55552	12069
1 1/8	1/4 x 1/8	44156	11838	44160	50126
1 3/16	1/4 x 1/8	11140	11580	11840	12071
1 1/4	1/4 x 1/8	11841	12327	12462
1 1/4	5/16 x 5/32	11581	12073
1 5/16	5/16 x 5/32	59046	48273
1 3/8	5/16 x 5/32	11842	12329	50127
1 7/16	3/8 x 3/16	45257	11844	12075	12465
1 1/2	5/16 x 5/32
1 1/2	3/8 x 3/16	11846	12077	12332	12466
1 9/16	3/8 x 3/16	11848
1 5/8	3/8 x 3/16	11849	12334	12468
1 3/4	3/8 x 3/16	12079	12336	46818
1 3/4	7/16 x 7/32	44159
1 7/8	1/2 x 1/4	12337	12472
1 15/16	1/2 x 1/4	12082	12339
2	1/2 x 1/4	12341	12476
2 1/8	1/2 x 1/4	44064	12477
2 1/4	1/2 x 1/4	12480
2 3/8	5/8 x 5/16	12482

- Notes:**
1. These "LC" hubs are drilled and tapped to accept collar mounting screws but the collar and hardware are not included.
 2. See L Type (inch or metric) coupling chart for standard hub.
 3. Tolerances for bore and keyways are found in Engineering Data section (pg. 16).
 4. All hubs are supplied standard with one set screw.

AL Type Couplings

Ordering requires selecting Item (UPC) numbers for two hubs and one spider.



AL Type Coupling Spiders

When referencing the Lovejoy Item (UPC) number, include 685144 as a prefix to the number shown in the table below.

Type	AL050	AL070	AL075	AL090/095	AL099/100	AL110	AL150
SOX (NBR) (solid)	10194	10406	10621	11070	11494	11724	18027
SOX (NBR) (open center)	10393	10620	10968	11492	11711
Urethane (solid)	37786	10395
Urethane (open center)	10411	10626	11075	11499	11729
Hytrel (solid)	25307	11717
Hytrel (open center)	25308	25309	25310	11486	38097
Bronze (open center)	10198	10409	10624	11073	11497	11727
Snap Wrap w/ring	24669	24670	24671
Snap Wrap no ring	11071	11495	11725

Note: AL Type couplings use the same spiders as L Type couplings, except AL150 which has four jaws instead of three.

AL Type Metric Hubs

Standard Bore and Keyway Chart

When referencing the Lovejoy Item (UPC) number, include 685144 as a prefix to the number shown in the table below.

Bore mm	Keyway mm	AL050	AL070	AL075	AL090	AL095	AL099	AL100	AL110	AL150
8	No KW	48973
10	3 x 1.4	41924	56514
11	4 x 1.8	65694	51098	58620
12	4 x 1.8	56487	64655	60429
14	5 x 2.3	65696	47302	58621	56800	58624
15	5 x 2.3	62906	49633	58622	56801	49629
16	5 x 2.3	52221	47014	45012
17	5 x 2.3	60887	44712	59164
19	6 x 2.8	65698	47427	44679	47012	58625	47253	59064
20	No KW	56137
20	6 x 2.8	59394	61478	48347	49634	49630	49631	60878
22	6 x 2.8	47013
24	8 x 3.3	45736	58626	44058	45690	64634
25	8 x 3.3	65469	49709	55687	45933	64633
28	8 x 3.3	47015	58627	47393	45463
30	8 x 3.3	52048	58266	49632	45063
32	10 x 3.3	54417	44347
35	10 x 3.3	46215	64803
36	10 x 3.3	51737
38	10 x 3.3	52692	58215
42	12 x 3.3	45404
46	14 x 3.8	64119

- Notes:**
1. Tolerances for bore and keyways are found in Engineering Data section (pg. 14).
 2. Lovejoy does not recommend reborring AL hubs.
 3. All hubs are supplied standard with one set screw, except the AL150 which is provided with two set screws.

AL Type Couplings

Ordering requires selecting Item (UPC) numbers for two hubs and one spider.



AL Type Inch Hubs

Standard Bore and Keyway Chart

When referencing the Lovejoy Item (UPC) number, include 685144 as a prefix to the number shown in the table below.

Bore	Keyway	AL050	AL070	AL075	AL090	AL095	AL099	AL100	AL110	AL150
1/4	No KW	10252	10463	10630	10791
5/16	No KW	10253	10464	10631	10792
3/8	No KW	10254	10466	10632	10793
7/16	No KW	10256	10469	10633	10794
1/2	No KW	10257	10471	10634	10795	17847	17880	17914
1/2	1/8 x 1/16	49706	10473	10635	10796	17848	17881	17915
9/16	No KW	10637	10797	56473
9/16	1/8 x 1/16	10638	44812	37994	44323	17917
5/8	No KW	10259	10480	61817	44004	17977	18035
5/8	3/16 x 3/32	10482	10639	10798	17850	17882	17918	38888	44828
11/16	3/16 x 3/32	45227	10799	17851	45494	17919	44059	46642
3/4	1/8 x 1/16	47835	47725	46295
3/4	3/16 x 3/32	10491	10640	10800	17852	17883	17920	17978	18036
13/16	3/16 x 3/32	10641	10801	17853	17884	17921
7/8	3/16 x 3/32	10642	10802	17854	17885	17922	17979	18037
15/16	1/4 x 1/8	17855	17886	17923	17980	18038
1	1/4 x 1/8	17856	17887	17924	17981	18039
1 1/16	1/4 x 1/8	17857	17888	17925	26094	18040
1 1/8	1/4 x 1/8	17858	17889	17926	17982	18041
1 3/16	1/4 x 1/8	17890	17927	17983	18042
1 1/4	1/4 x 1/8	17928	17984	18043
1 5/16	5/16 x 5/32	17929	17985	18044
1 3/8	5/16 x 5/32	17930	17986	18045
1 7/16	3/8 x 3/16	45508	17987	18046
1 1/2	3/8 x 3/16	17988	18047
1 9/16	3/8 x 3/16	17989	18048
1 5/8	3/8 x 3/16	17990	18049
1 11/16	3/8 x 3/16	18050
1 3/4	3/8 x 3/16	18051
1 13/16	1/2 x 1/4	18052
1 7/8	1/2 x 1/4	18053

Notes:

1. Tolerances for bore and keyways are found in Engineering Data section (pg. 16).
2. Lovejoy does not recommend reborning AL hubs.
3. All hubs are supplied standard with one set screw, except the AL150 which is provided with two set screws.



SS Type Inch Hubs

Standard Bore and Keyway Chart

When reference the Lovejoy Item (UPC) number, include 685144 as a prefix to the number shown in the table shown.

Size	RSB	1/4	1/2	5/8	3/4	7/8	1"	1-1/8	1-3/8	1-1/2	1-5/8	1-3/4	1-7/8
SS075	70001	70006	70007	70008	70009	70010	-	-	-	-	-	-	-
SS095	70002	70011	70011	70012	70013	70014	70015	70016	-	-	-	-	-
SS100	70003	-	-	-	70017	70018	70019	70020	70022	-	-	-	-
SS110	70004	-	-	-	-	-	70023	70024	70026	70027	70028	-	-
SS150	70005	-	-	-	-	-	70029	70030	70032	70033	70034	70035	70036

Radially Removable Spacer—RRS Couplings

The RRS Type couplings range from sizes RRS090 to RRS225. Ordering requires selecting Item (UPC) numbers for:

RRS090—RRS110:

- 2 Standard RRS Hubs
- 1 Spacer Assembly consisting of:
 - 2 snap wrap spiders w/o ring
 - 2 collars with screws
 - 1 spacer

RRS150—RRS225:

- 1 Standard RRS Hub
- 1 Standard RRSC Hub—
Drilled for Collar
- 1 Spacer Assembly consisting of:
 - 2 snap wrap spiders w/o ring
 - 2 collars with screws
 - 1 spacer



Note: RRS Type Inch Hubs provided standard with two set screws at 90°. Metric Hubs provided standard with one set screw.

RRS Type Coupling Spacer Assembly

When referencing the Lovejoy Item (UPC) number, include 685144 as a prefix to the number shown in the table below.

Description	RRS090	RRS095	RRS099	RRS100	RRS110	RRS150	RRS190	RRS225
3½" Spacer Assembly	12620	12620	12630	12630	12644	12660	12676	12685
5" Spacer Assembly	26119	26119	26123	26123	26128	26770	27042	27041
7" Spacer Assembly	26120	26120	26124	26124	26129	27044	27043	27039
100mm Spacer Assembly	55563	55563	55567	55567	55570	61056	61057	61058
140mm Spacer Assembly	55281	55281	55569	55569	55571	55572	55573	55574
180mm Spacer Assembly	61055	61055	55575	55575	55576	55577	55578	55579

Note: Spacer length denotes separation between shaft ends. Assembly includes spacer, two snap wrap spiders w/o ring, and two collars with screws. See page JW-8 for ordering information on spiders.

RRS Type Metric Hubs

Standard Bore and Keyway Chart

When referencing the Lovejoy Item (UPC) number, include 685144 as a prefix to the number shown in the table below.

Bore mm	Keyway mm	RRS090	RRS095	RRS099	RRS100	RRS110	RRS150	RRS190	RRS225
12	No KW	48276
14	No KW	41461	41465
14	5 x 2.3	51231	41466	60094	45101
15	No KW	46561	52697	41469
15	5 x 2.3	52096	45778	46972	47123
16	5 x 2.3	49198	41325	52098	55534	52092	52471
19	No KW	10777	41471
19	6 x 2.8	41462	41326	44157	41329	49700	48821	46717
20	6 x 2.8	41925	41467	47122	52093	41804	61497
23	8 x 3.3	50135
24	8 x 3.3	41463	41327	41990	41330	48301	48182	59109
25	8 x 3.3	41464	41468	45055	41470	41906	46751	52153
28	8 x 3.3	41328	50103	41331	41333	45679	52976
30	8 x 3.3	47132	48317	45681	41738	44471	48982
32	No KW	41472	41473	48319
32	10 x 3.3	41332	41334	41873	45562	41849
35	10 x 3.3	49925	45682	46562	58035	52197
38	10 x 3.3	41335	41337	41474	49664
40	12 x 3.3	45683	48318	48320	49605
42	12 x 3.3	41336	41338	41475	47492

Note: DIN Metric Hubs are standard with one set screw only.

Radially Removable Spacer—RRS Couplings



RRS Type Inch Hubs

Standard Bore and Keyway Chart

When referencing the Lovejoy Item (UPC) number, include 685144 as a prefix to the number shown in the table below.

Bore	Keyway	RRS090	RRS095	RRS099	RRS100	RRS110	RRS150	RRS190	RRS225
7/16	No KW	41229	52184	41231
7/16	3/16 x 3/32
1/2	No KW	41227	50357	41230	52199
1/2	1/8 x 1/16	56512	38145	38151
1/2	3/16 x 3/32
9/16	3/16 x 3/32	44474
5/8	No KW	38159	45265
5/8	3/16 x 3/32	38143	38146	38168	38152	50163
3/4	No KW	45273	45290
3/4	3/16 x 3/32	38144	38147	38169	38153	38160	45266	45292
7/8	1/4 x 1/8	52966
7/8	3/16 x 3/32	41228	38148	38170	38154	38161	45267	45274	45291
1	1/4 x 1/8	51672	38149	38171	38155	38162	45268	45275	45294
1 1/8	1/4 x 1/8	38150	38172	38156	38163	45153	45276	45295
1 1/8	5/16 x 5/32	48104
1 1/4	1/4 x 1/8	38157	38164	45392	48503	50743
1 3/8	5/16 x 5/32	38158	38165	44002	44725	45296
1 7/16	3/8 x 3/16	51579	49659	48933	49658
1 1/2	3/8 x 3/16	40816	49638	46628	45297
1 5/8	3/8 x 3/16	38166	41880	45277	45298
1 3/4	3/8 x 3/16	45162	45278	45299
1 7/8	1/2 x 1/4	44214	45279	41953
2	1/2 x 1/4	45280	45300
2 1/8	1/2 x 1/4	44724
2 3/8	5/8 x 5/16	45106

Note: RRS inch hubs are standard with two set screws, including those with no keyway.

RRS Type Couplings—RRSC Hubs (Collar Drilled)

When referencing the Lovejoy Item (UPC) number, include 685144 as a prefix to the number shown in the tables below.

Metric Hubs

Standard Bore and Keyway Chart

Bore mm	Keyway mm	RRSC150	RRSC190	RRSC225
32	No KW	55675	55679	55683
38	10 x 3.3	55676	55680
40	12 x 3.3	55677	55681
42	12 x 3.3	55678	55682

Note: RRSC hubs are standard with two set screws and are drilled to accept retaining collar. Collars are supplied with spacers.

Inch Hubs

Standard Bore and Keyway Chart

Bore	Keyway	RRSC150	RRSC190	RRSC225
5/8	No KW	45269
3/4	No KW	45281	45301
3/4	3/16 x 3/32	45312	45303
7/8	3/16 x 3/32	45270	45282	45293
1	1/4 x 1/8	45271	45283	45305
1 1/8	1/4 x 1/8	44779	45284	45105
1 3/8	5/16 x 5/32	44006	45285	45306
1 1/2	3/8 x 3/16	49639	45307
1 5/8	3/8 x 3/16	41881	45286	45308
1 3/4	3/8 x 3/16	45287	45309
1 7/8	1/2 x 1/4	45272	45288	41954
2	1/2 x 1/4	45289	45310
2 1/8	1/2 x 1/4	45311

Note: RRSC inch hubs are standard with two set screws and are drilled to accept retaining collar. Collars are supplied with spacers.

C Type Couplings

Complete coupling selection includes two standard hubs, one cushion set, and one collar with hardware.

Cushions and Collar Chart

When referencing the Lovejoy Item (UPC) number, include 685144 as a prefix to the number shown in the table below.

Size →	C226	C276	C280	C285	C295	C2955
Number of Cushions	6	6	6	6	6	10
SXB(NBR) cushion set	14547	14633	14712	14771	14805	14856
Hytrek cushion set	27529	14637	14716	14774	14808	14859
Bronze cushion set	14545	51914	51915
Collar with hardware	40122	40123	40124	40292	40293	40293



Note: Chemical resistance and compatibility for cushions is described in Engineering Data section (pg. ED-13).

C Type Metric Hubs

Standard Bore and Keyway Chart

When referencing the Lovejoy Item (UPC) number, include 685144 as a prefix to the number shown in the table below.

Bore mm	Keyway mm	C226	C276	C280	C285	C295	C2955
30	8 x 3.3	62792
35	10 x 3.3	60243	47386
38	10 x 3.3	45348	62160
40	12 x 3.3	49379	54037
42	12 x 3.3	45219
45	14 x 3.8	52550	44723	58265
48	14 x 3.8	54288	52205
55	16 x 4.3	58011	58444	49012
60	18 x 4.4	47265	49378
65	18 x 4.4	52008	58676
70	20 x 4.9	59032	56794	54355	58677
75	22 x 5.4	47813	58678
80	22 x 5.4	44487	58675	58679
90	25 x 5.4	54363
95	25 x 5.4	62695

Note: RSB (Rough Stock Bore) hub has no keyway or set screw hole, it is not useable as shown and must be machined to proper bore tolerances. Hub includes inside sleeve and is drilled and tapped for collar bolts. Non-standard bores available—consult Lovejoy Engineering. For RSB hub part numbers see the C Type Inch Hub chart.

C Type Inch Hubs

Standard Bore and Keyway Chart

When referencing the Lovejoy Item (UPC) number, include 685144 as a prefix to the number shown in the table below.

Bore	Keyway	C226	C276	C280	C285	C295	C2955
7/8 RSB		40125	40126
1 1/8	1/4 x 1/8	26036	26050
1 1/4 RSB		26067	41036
1 1/4	1/4 x 1/8	26037	26051	48988	47173
1 3/8	5/16 x 5/32	26038	26052	46278	55546
1 7/16	3/8 x 3/16	26039
1 1/2 RSB		41037
1 1/2	3/8 x 3/16	26040	26053	46277	48366	44824
1 5/8	3/8 x 3/16	26041	26054	46194	41892	56078
1 3/4 RSB		41038
1 3/4	3/8 x 3/16	26042	26055	44011	52311	45780
1 7/8	1/2 x 1/4	26043	26056	44012	51533	47080	49075
2	1/2 x 1/4	26044	26057	48194
2 1/8	1/2 x 1/4	26045	26058	44370	49809	44711
2 1/4	1/2 x 1/4	26046	44547
2 3/8	5/8 x 5/16	26047	26060	44014	47288	44825	52703
2 1/2	5/8 x 5/16	26048	46120	51998	56779	45249	48454
2 5/8	5/8 x 5/16	46755	44013	50145	54549
2 7/8	3/4 x 3/8	26064	51525	49456	52702	48108
3	3/4 x 3/8	48193
3 3/8	7/8 x 7/16	47171	45402	49077
3 1/2	7/8 x 7/16	46844	52988	44545
3 5/8	7/8 x 7/16	50106
3 3/4	7/8 x 7/16	58378
3 7/8	1 x 1/2	48247	49351
4	1 x 1/2	55016

Note: RSB (Rough Stock Bore) hub has no keyway or set screw hole, it is not useable as shown and must be machined to proper bore tolerances. Hub includes inside sleeve and is drilled and tapped for collar bolts. Non-standard bores available—consult Lovejoy Engineering.

JW

H Type Couplings

Complete H Type coupling selection includes two hubs, two inside sleeves, one cushion set, and one collar with hardware. H Type coupling hubs are supplied with an inside sleeve. For technical assistance, please contact Lovejoy Engineering.



Cushions and Collar Chart

When referencing the Lovejoy Item (UPC) number, include 685144 as a prefix to the number shown in the table below.

Size →	H3067	H3567	H3667	H4067	H4567
No. of Cushions	14	14	14	14	14
SXB cushion set	15365	15386	15419	15457	15473
Hytrell cushion set	15367	15388	45223	15459	55475
Collar w/hardware	15361	15381	15411	55472	55476

H Type Hubs

Rough Stock Bore Chart

When referencing the Lovejoy Item (UPC) number, include 685144 as a prefix to the number shown in the table below.

Bore	H3067	H3567	H3667	H4067	H4567
2 ¹ / ₈ RSB	48070
2 ⁵ / ₈ RSB	50883
3 RSB	47878
3 ¹ / ₄ RSB	55473
3 ¹ / ₂ RSB	55477

- Notes:**
1. RSB (Rough Stock Bore) hub has no keyway or set screw hole.
 2. RSB bores should not be used as shown and may need additional machining to reach proper tolerances.

Radially Removable Spacer—RRC Coupling

The RRC Type sizes range from RRC226 to RRC2955.

Ordering requires selecting Item (UPC) numbers for:

2 RRC Hub Adapters (includes bolts)

1 Spacer assembly consisting of:

- 2 RRC Jaw Rings
- 1 collar with hardware
- 1 set of SXB (NBR) cushions

RRC Type Spacer Assembly

When referencing the Lovejoy Item (UPC) number, include 685144 as a prefix to the number shown in the table below.

Description	RRC226	RRC276	RRC280	RRC285	RRC295	RRC2955
3½" Spacer Assembly	55709	55712	55715	55718
4" Spacer Assembly	55721	55724
5" Spacer Assembly	55710	55713	55716	55719	55722	55751
7" Spacer Assembly	55711	55714	55717	55720	55723	55752

RRC Type Adapter Hubs

Standard Rough Stock Bore Chart

When referencing the Lovejoy Item (UPC) number, include 685144 as a prefix to the number shown in the table below.

Bore	RRC226	RRC276	RRC280	RRC285	RRC295	RRC2955
7/8 RSB	55770	55771
1¼ RSB	52030	55772
1½ RSB	55773
1¾ RSB	55774

Jaw Type Coupling Ratings

See chart on page JW-7 for Bronze and Urethane ratings.

Size	Elastomeric Member	Number of Jaws	Basic HP Ratings @ Varying RPM				Torque Rating		Maximum Bore		Max. RPM x1000
			100	1200	1800	3600	in-lbs	Nm	inch	mm	
L, AL & LC TYPE											
L035	SOX (NBR)	2	.006	.07	.1	.22	3.5	.40	.375	9	31.0
L050/AL050	SOX (NBR)	2	.042	.50	.75	1.51	26.3	2.97	.625	16	18.0
L050/AL050	Hytrel	2	.080	.96	1.43	2.88	50.0	5.65	.625	16	18.0
L070/AL070	SOX (NBR)	2	.070	.84	1.23	2.52	43.2	4.88	.750	19	14.0
L070/AL070	Hytrel	2	.180	2.16	3.26	6.48	114.0	12.88	.750	19	3.6
L075/AL075	SOX (NBR)	3	.140	1.68	2.57	5.04	90.0	10.17	.875	22	11.0
L075/AL075	Hytrel	3	.360	4.32	6.48	12.96	227.0	25.65	.875	22	3.6
L090/AL090/LC090	SOX (NBR)	3	.230	2.76	4.11	8.28	144.0	16.27	1.00	25	9.0
L090/AL090	Hytrel	3	.640	7.68	11.50	23.04	401.0	45.31	1.00	25	3.6
L095/AL095/LC095	SOX (NBR)	3	.310	3.72	5.50	11.16	194.0	21.92	1.12	28	9.0
L095/AL095	Hytrel	3	.890	10.68	16.00	32.04	561.0	63.38	1.12	28	3.6
L099/AL099/LC099	SOX (NBR)	3	.500	6.00	9.10	18.00	318.0	35.93	1.18	30	7.0
L099/AL099	Hytrel	3	1.260	15.12	22.60	45.36	792.0	89.48	1.18	30	3.6
L100/AL100/LC100	SOX (NBR)	3	.660	7.92	11.90	23.76	417.0	47.11	1.38	35	7.0
L100/AL100	Hytrel	3	1.800	21.60	32.40	64.80	1134.0	128.12	1.38	35	3.6
L110/AL110/LC110	SOX (NBR)	3	1.260	15.12	23.00	45.36	792.0	89.48	1.62	42	5.0
L110/AL110	Hytrel	3	3.600	43.20	65.00	129.60	2268.0	256.25	1.62	42	5.0
L150/LC150	SOX (NBR)	3	2.000	24.00	35.00	72.00	1240.0	140.10	1.88	48	5.0
L150	Hytrel	3	5.900	70.80	106.00	212.40	3708.0	418.95	1.88	48	5.0
AL-150	SOX (NBR)	4	2.300	27.60	41.40	82.80	1450.0	163.83	1.88	48	5.0
L190/LC190	SOX (NBR)	3	2.700	32.40	49.00	97.20	1728.0	195.24	2.12	55	5.0
L190	Hytrel	3	7.400	88.80	134.00	266.40	4680.0	528.77	2.12	55	5.0
L225/LC225	SOX (NBR)	3	3.700	44.40	67.00	133.20	2340.0	264.38	2.62	65	4.2
L225	Hytrel	3	9.900	118.80	178.00	356.40	6228.0	703.67	2.62	65	4.2
L276	SOX (NBR)	3	7.500	90.00	135.00	+	4716.0	532.84	2.88	73	1.8
C Type											
C226	SXB (NBR)	3	4.700	56.40	85.00	169.20	2988.0	337.60	2.50	64	4.8
C226	Hytrel	3	9.400	112.80	170.00	338.40	5940.0	671.13	2.50	64	4.8
C276	SXB (NBR)	3	7.500	90.00	135.00	270.00	4716.0	532.84	2.88	73	4.2
C276	Hytrel	3	15.000	180.00	269.00	540.00	9432.0	1065.67	2.88	73	4.2
C280	SXB (NBR)	3	12.000	144.00	216.00	+	7560.0	854.17	3.00	76	3.5
C280	Hytrel	3	22.000	264.00	396.00	+	13866.0	1566.65	3.00	76	3.5
C285	SXB (NBR)	3	14.600	175.20	262.00	+	9182.0	1037.43	4.00	102	3.2
C285	Hytrel	3	26.000	312.00	476.00	+	16660.0	1882.33	4.00	102	3.2
C295	SXB (NBR)	3	18.000	216.00	324.00	+	11340.0	1281.25	3.50	89	2.3
C295	Hytrel	3	36.000	432.00	648.00	+	22680.0	2562.50	3.50	89	2.3
C2955	SXB (NBR)	5	30.000	360.00	540.00	+	18900.0	2135.42	4.00	102	2.3
C2955	Hytrel	5	60.000	720.00	1080.00	+	37800.0	4270.83	4.00	102	2.3
H Type											
H3067	SXB (NBR)	7	53.000	636.00	954.00	+	33396.0	3773.25	4.50	114	2.3
H3067	Hytrel	7	75.000	900.00	1348.00	+	47196.0	5332.44	4.00	102	2.3
H3567	SXB (NBR)	7	74.000	888.00	1332.00	+	46632.0	5268.72	5.00	127	2.1
H3567	Hytrel	7	100.000	1200.00	1799.00	+	63000.0	7118.06	4.50	114	2.1
H3667	SXB (NBR)	7	103.000	1236.00	1851.00	+	64812.0	7322.78	5.62	143	1.9
H3667	Hytrel	7	140.000	1680.00	2519.00	+	88200.0	9965.28	5.00	127	1.9
H4067	SXB (NBR)	7	140.000	1680.00	2520.00	+	88224.0	9967.99	6.25	159	1.8
H4067	Hytrel	7	200.000	2400.00	3600.00	+	126000.0	14236.11	5.50	140	1.8
H4567	SXB (NBR)	7	190.000	2280.00	+	+	119700.0	13524.30	7.00	178	1.5
H4567	Hytrel	7	270.000	3240.00	+	+	170000.0	19207.45	6.00	152	1.5
RRS Type											
RRS090	SOX (NBR)	3	.230	2.76	4.11	8.28	144.0	16.27	1.00	25	3.6
RRS095	SOX (NBR)	3	.310	3.72	5.50	11.16	194.0	21.92	1.12	28	3.6
RRS099	SOX (NBR)	3	.500	6.00	9.10	18.00	318.0	35.93	1.18	30	3.6
RRS100	SOX (NBR)	3	.660	7.92	11.90	23.76	417.0	47.11	1.38	35	3.6
RRS110	SOX (NBR)	3	1.260	15.12	23.00	45.36	792.0	89.48	1.62	42	3.6
RRS150	SOX (NBR)	3	2.000	24.00	35.00	72.00	1240.0	140.10	1.88	48	3.6
RRS190	SOX (NBR)	3	2.700	32.40	49.00	97.20	1728.0	195.24	2.12	55	3.6

JW-20 Note: + indicates exceeds RPM capacity; see page JW-3 for other speed limits due to the elastomer type.

Elastomers In Compression (Spiders)

JW

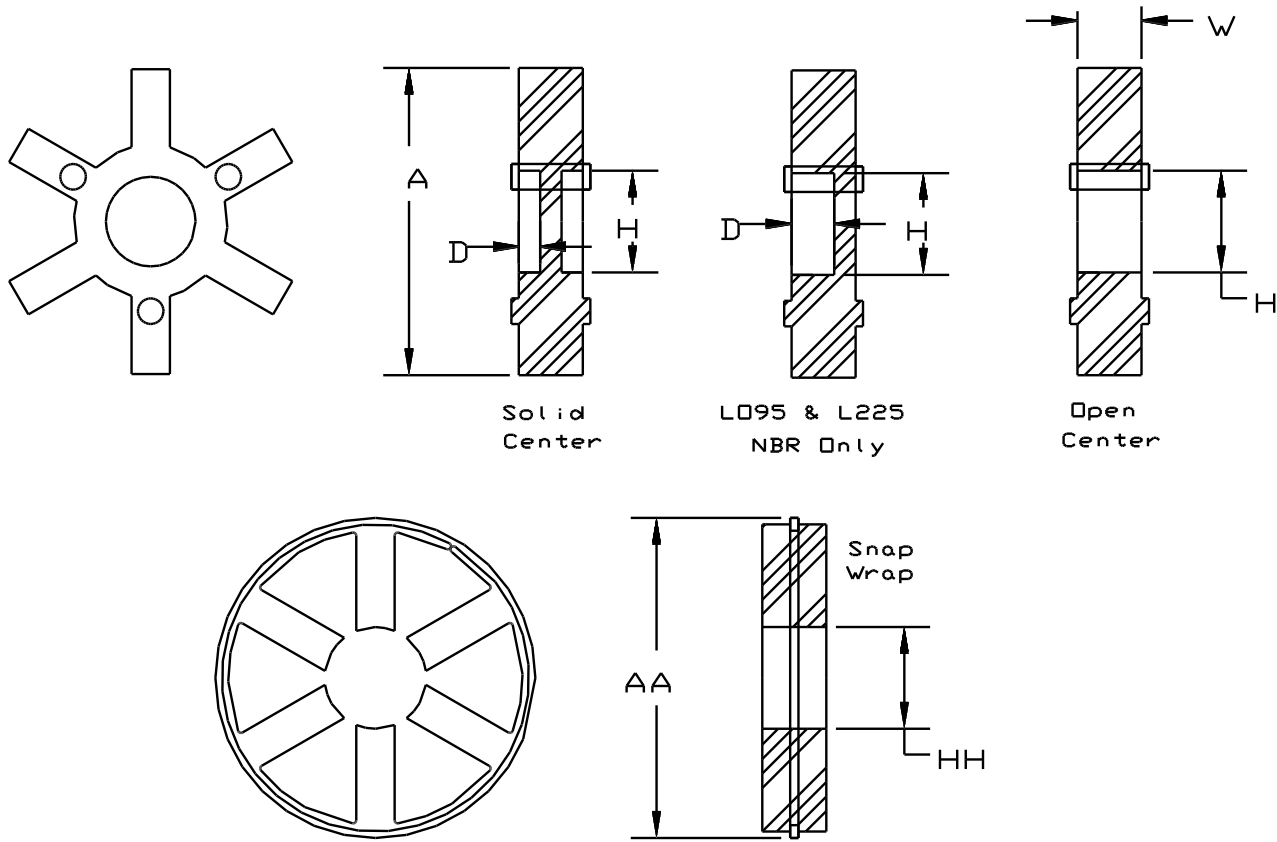

Elastomer Dimensional Data—Inch

Size	Solid Center Spiders								Open Center Spiders						Snap Wrap Spiders			All	
	Material Available				Dimensions				Material Available				Dimensions		Material	Dimensions		W	B
	NBR SOX	Urethane URE	Hytrel HYT	Bronze BRZ	A	D	H	NBR SOX	Ureth. URE	Hytrel HYT	Bronze BRZ	A	H	NBR	AA	HH			
L035	X	0.62	N/A28	.21	
L050	X	X	X	1.07	X	1.07	0.31	N/A42	.27	
L070	X	X	1.38	X	X	X	X	1.38	0.50	N/A42	.27	
L075	X	1.75	X	X	X	X	1.75	0.75	N/A44	.27	
L090/L095	X	2.12	.18	0.88	X	X	X	X	2.12	0.88	X	2.56	1.06	.44	.36	
L099/L100	X	2.54	.25	1.03	X	X	X	X	2.54	1.03	X	3.08	1.37	.61	.43	
L110	X	X	3.31	NBR .25 HYT .18	1.19	X	X	X	X	3.31	1.18	X	3.87	1.50	.75	.45	
L150	X	X	3.75	NBR .31 HYT .21	1.25	X	X	X	X	3.75	1.25	X	4.56	1.75	.88	.59	
L190	X	X	4.50	NBR .31 HYT .18	1.38	X	X	X	X	4.50	1.38	X	5.18	2.25	.88	.60	
L225	X	X	4.98	NBR .38 HYT .18	1.75	X	X	X	X	4.98	1.75	URE.	5.44	2.75	.88	.73	
L276	X	X	6.19	1.75	N/A	1.45	.75	

Notes: 1. X indicates Available.
2. See pages JW-3 and JW-7 for more information on spiders.

L Type, C Type & H Type Couplings

JW

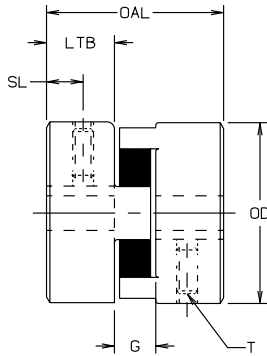

Style 1

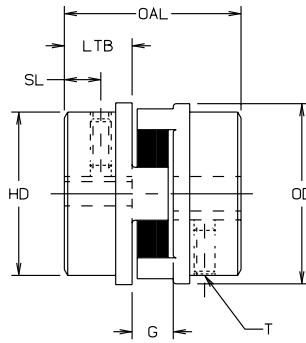

Style 2

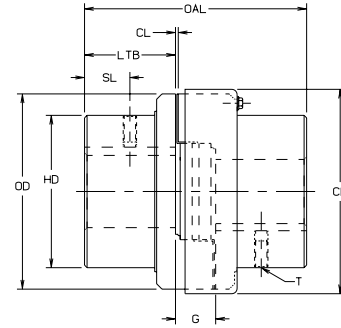

Style 3

Dimensional Data—Inch

Size	Style No.	Bore		Outer Dia. OD	Overall Length OAL	Gap G	Length			Set Screw Location SL	Collar Dia. CD	Set Screw Size T	Weight lbs		Moment of Inertia WR ² lb-in ² (Solid)
		Min.	Max.				Thru Bore LTB	Hub Dia. HD	Clearance CL				Min. Bore	Max. Bore	
L035	1	.125	.375	.63	.81	0.28	0.27	0.63	N/A	0.13	N/A	#6-32	0.1	0.1	.003
L050	1	.250	.625	1.08	1.71	0.48	0.62	1.08	N/A	0.31	N/A	1/4-20	0.3	0.2	.054
L070	1	.250	.750	1.36	1.98	0.48	0.75	1.36	N/A	0.38	N/A	1/4-20	0.6	0.4	.115
L075	1	.250	.875	1.75	2.13	0.50	0.82	1.75	N/A	0.31	N/A	1/4-20	1.0	0.8	.388
L090	1	.250	1.000	2.11	2.15	0.52	0.82	2.11	N/A	0.44	N/A	1/4-20	1.5	1.2	.772
L095	1	.437	1.125	2.11	2.51	0.52	1.00	2.11	N/A	0.44	N/A	5/16-18	1.8	1.3	.890
L099	1	.437	1.188	2.54	2.84	0.71	1.06	2.54	N/A	0.44	N/A	5/16-18	2.5	2.0	2.048
L100	1	.437	1.375	2.54	3.48	0.71	1.38	2.54	N/A	0.44	N/A	5/16-18	3.2	2.4	2.783
L110	1	.625	1.625	3.32	4.22	0.88	1.68	3.32	N/A	0.75	N/A	3/8-16	6.6	5.3	8.993
L150	1	.625	1.875	3.75	4.50	1.00	1.75	3.75	N/A	0.75	N/A	3/8-16	8.8	7.0	11.477
L190	2	.750	2.125	4.50	4.86	1.00	1.94	4.00	N/A	0.88	N/A	1/2-13	15.3	12.3	39.256
L225	2	.750	2.625	5.00	5.34	1.00	2.18	4.25	N/A	1.00	N/A	1/2-13	19.6	15.0	65.000
L276	2	.875	2.875	6.18	7.82	1.58	3.12	5.00	N/A	1.56	N/A	1/2-13	40.0	30.5	188.000
C226	3	.875	2.500	5.15	7.00	1.50	2.75	4.12	.12	1.38	5.50	1/2-13	29.0	22.0	74
C276	3	.875	2.875	6.18	7.87	1.63	3.12	5.00	.12	1.56	6.53	1/2-13	47.0	36.0	188
C280	3	1.250	3.000	7.50	7.87	1.63	3.12	5.50	.12	1.56	7.81	1/2-13	61.0	49.0	362
C285	3	1.250	4.000	8.50	9.13	1.63	3.75	6.50	.12	1.75	8.88	5/8-11	87.0	68.0	642
C295	3	1.500	3.500	9.12	9.38	1.88	3.75	6.25	.12	1.88	9.62	5/8-11	97.0	78.0	862
C2955	3	1.750	4.000	9.12	10.38	1.88	4.25	7.12	.12	2.12	9.62	5/8-11	117.0	90.0	932
H3067	3	2.125	4.500	10.00	11.62	2.12	4.75	7.00	.12	2.37	10.68	5/8-11	162.0	123.0	1485
SXB(NBR) HYTREL				10.00	11.62	2.12	4.75	7.00	.12	2.37	10.68	5/8-11	162.0	123.0	1485
H3567	3	2.625	5.000	11.00	12.38	2.38	5.00	7.75	.12	2.50	11.68	5/8-11	246.0	195.0	2174
SXB(NBR) HYTREL				11.00	12.38	2.38	5.00	7.75	.12	2.50	11.68	5/8-11	246.0	195.0	2174
H3667	3	3.000	5.625	12.00	13.88	2.62	5.63	8.75	.12	2.81	12.45	3/4-10	262.0	190.0	3591
SXB(NBR) HYTREL				12.00	13.88	2.62	5.63	8.75	.12	2.81	12.45	3/4-10	262.0	190.0	3591
H4067	3	3.250	6.250	13.25	15.38	2.88	6.25	9.75	.12	3.12	14.00	3/4-10	390.0	291.0	6287
SXB(NBR) HYTREL				13.25	15.38	2.88	6.25	9.75	.12	3.12	14.00	3/4-10	390.0	291.0	6287
H4567	3	3.500	7.000	14.50	17.12	3.12	7.00	10.75	.12	3.50	15.75	3/4-10	575.0	435.0	10565
SXB(NBR) HYTREL				14.50	17.12	3.12	7.00	10.75	.12	3.50	15.75	3/4-10	575.0	435.0	10565

- Notes:**
1. N/A indicates not applicable.
 2. Maximum bore is less for H Type couplings with Hytrel due to increased torque capacity.
 3. Jaw coupling hubs are standard with one set screw, for two set screws see RRS & RRC sections.
 4. See pages JW-7 and JW-20 for Performance Data.

LC Type Couplings

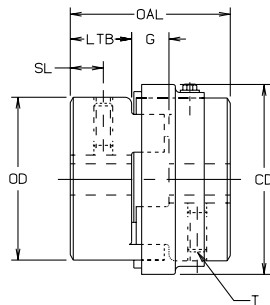

Style 1

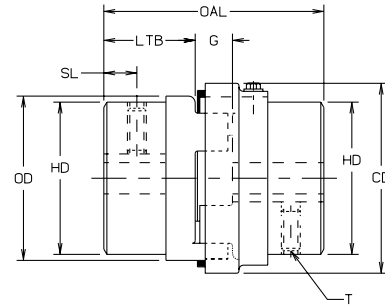

Style 2

LC Type Dimensional Data—Inch

Size	Style No.	Bore		Outer Dia. OD	Overall Length OAL	Jaw Gap G	Length			Set Screw Location SL	Collar Dia. CD	Set Screw Size T	Weight lbs		Moment of Inertia WR ² lb-in ² (Solid)
		Min.	Max.				Thru Bore LTB	Hub Dia. HD	Clearance CL				Solid	Max. Bore	
LC090	1	.250	1.00	2.11	2.12	.50	.81	2.11	N/A	.44	2.54	1/4-20	1.5	1.2	.772
LC095	1	.437	1.12	2.11	2.50	.50	1.00	2.11	N/A	.44	2.54	5/16-18	1.8	1.3	.890
LC099	1	.437	1.18	2.53	2.87	.75	1.06	2.53	N/A	.44	3.11	5/16-18	2.5	2.0	2.048
LC100	1	.437	1.37	2.53	3.50	.75	1.38	2.53	N/A	.44	3.11	5/16-18	3.5	2.5	2.783
LC110	1	.625	1.62	3.31	4.25	.87	1.69	3.31	N/A	.75	3.81	3/8-16	6.6	5.0	8.993
LC150	1	.625	1.88	3.75	4.50	1.00	1.75	3.75	N/A	.75	4.41	3/8-16	9.1	7.0	11.477
LC190	2	.750	2.12	4.50	4.88	1.00	1.94	4.00	N/A	.88	5.01	1/2-13	17.0	13.0	39.256
LC225	2	.875	2.62	5.00	5.38	1.00	2.19	4.25	N/A	1.00	5.61	1/2-13	23.0	18.0	65.003

Note: N/A indicates not applicable

AL Type Coupling

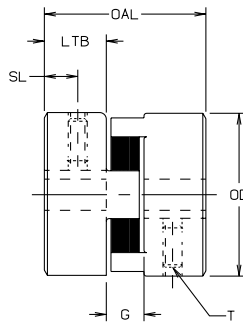

Style 1

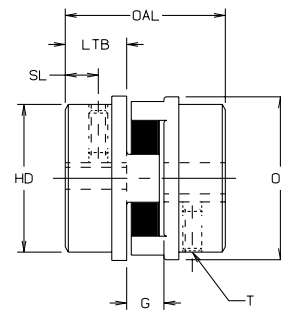

Style 2

AL Type Dimensional Data—Inch

Size	Style No.	Bore		Outer Dia. OD	Overall Length OAL	Jaw Gap G	Length			Set Screw Location SL	Collar Dia. CD	Set Screw Size T	Weight lbs		Moment of Inertia WR ² lb-in ² (Solid)
		Min.	Max.				Thru Bore LTB	Hub Dia. HD	Clearance CL				Solid	Max. Bore	
AL050	1	.250	.625	1.08	1.60	.48	.62	1.08	N/A	.31	N/A	1/4-20	0.2	0.2	0.020
AL070	1	.250	.750	1.36	2.00	.50	.75	1.36	N/A	.38	N/A	1/4-20	0.3	0.2	0.040
AL075	2	.250	.875	1.75	2.12	.50	.81	1.53	N/A	.31	N/A	1/4-20	0.4	0.3	0.121
AL090	2	.500	.875	2.12	2.34	.52	.91	1.53	N/A	.34	N/A	1/4-20	0.5	0.4	0.271
AL095	1	.500	1.125	2.12	2.50	.50	1.00	2.12	N/A	.44	N/A	5/16-18	0.8	0.6	0.336
AL099	2	.500	1.187	2.53	2.81	.75	1.03	2.06	N/A	.44	N/A	5/16-18	1.0	0.8	0.644
AL100	2	.500	1.375	2.53	3.50	.75	1.37	2.41	N/A	.44	N/A	5/16-18	1.5	1.1	1.207
AL110	1	.625	1.625	3.31	4.25	.87	1.69	3.31	N/A	.75	N/A	5/16-18	2.7	2.1	3.531
AL150 ²	2	.625	1.875	4.25	4.50	1.00	1.75	3.19	N/A	.63	N/A	5/16-18 ²	3.7	2.8	7.002

- Notes:
1. N/A indicates not applicable
 2. Two set screws provided with AL150.
 3. See pages JW-7 and JW-20 for Performance Data.

RRS & RRC Type Dimensional Data—Inch

Size	Style No.	Bore Min.	Bore Max.	Hub Outer Diameter OD	Overall Length OAL	Spacer S	Length Thru Bore LTB	Hub Step Diameter HD	Clearance CL	Set Screw Location SL	Collar Diameter CD	Set Screw Size T	Weight lbs.
RRS090	1	.250	1.000	2.11	5.12	3.50	.8109	.43	2.50	1/4-20	1.7
					6.62	5.00							1.8
					8.62	7.00							1.9
RRS095	1	.437	1.125	2.11	5.50	3.50	1.0009	.43	2.50	5/16-18	1.9
					7.00	5.00							2.0
					9.00	7.00							2.1
RRS099	1	.437	1.187	2.53	5.62	3.50	1.0612	.44	3.12	5/16-18	2.2
					7.12	5.00							2.5
					9.12	7.00							2.8
RRS100	1	.437	1.375	2.53	6.25	3.50	1.3812	.44	3.12	5/16-18	3.2
					7.75	5.00							3.5
					9.75	7.00							3.8
RRS110	1	.625	1.625	3.31	6.88	3.50	1.6812	.75	3.81	5/16-18	6.2
					8.36	5.00							6.6
					10.36	7.00							7.2
RRS150	2	.625	1.875	3.75	7.00	3.50	1.7512	.62	4.44	3/8-16	12.2
					8.50	5.00							15.7
					10.50	7.00							20.3
RRS190	3	.750	2.125	4.50	7.38	3.50	1.94	4.00	.12	.88	5.00	1/2-13	23.0
					8.88	5.00							28.2
					10.88	7.00							35.0
RRS225	3	.750	2.625	5.00	7.88	3.50	2.18	4.25	.12	1.00	5.62	1/2-13	26.5
					9.38	5.00							33.0
					11.38	7.00							41.4
RRC226	4	.875	2.125	5.16	9.19	3.50	2.84	4.12	N/A	1.38	5.50	1/2-13	37.0
					10.68	5.00							43.0
					12.68	7.00							49.0
RRC276	4	.875	2.875	6.18	8.60	3.50	2.47	5.00	N/A	1.00	6.50	1/2-13	52.0
					9.94	5.00							59.0
					11.94	7.00							69.0
RRC280	4	1.250	3.375	7.50	8.50	3.50	2.47	5.50	N/A	1.00	7.81	1/2-13	66.0
					9.94	5.00							75.0
					11.94	7.00							87.0
RRC285	4	1.250	4.125	8.50	9.31	3.50	2.87	6.50	N/A	1.00	8.88	1/2-13	92.0
					10.75	5.00							104.0
					12.75	7.00							121.0
RRC295	4	1.500	4.125	9.12	9.50	4.00	2.75	6.50	N/A	1.38	9.56	1/2-13	100.0
					10.50	5.00							112.0
					12.50	7.00							128.0
RRC2955	4	1.750	4.125	9.12	9.50	4.00	2.75	6.50	N/A	1.88	9.56	5/8-11	96.0
					10.50	5.00							111.0
					12.50	7.00							132.0

- Notes: 1. N/A indicates not applicable.
 2. See pages JW-7 and JW-20 for Performance Data.

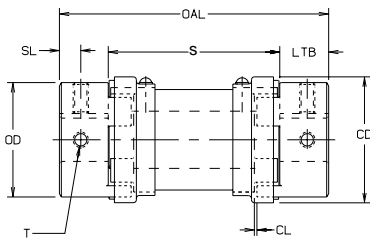

Style 1

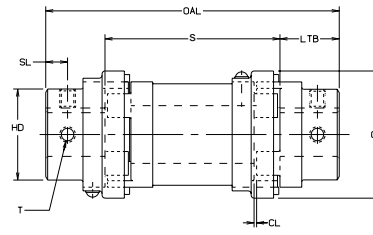

Style 2

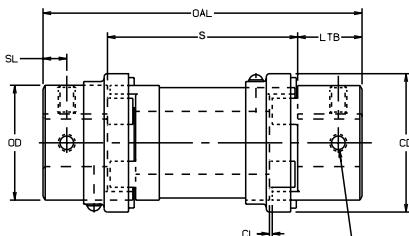

Style 3

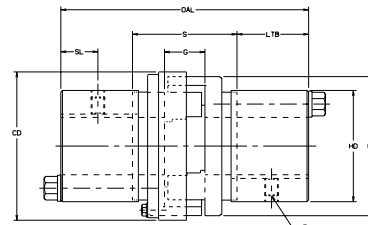

Style 4

RRS Dimensional Data—Metric Spacers

Size	Style No.	Bore (mm)		Distance Between Shafts S mm	Overall Length OAL mm	Spacer Weight lbs.	Spacer Weight Kg.
		Min.	Max.				
RRS090	1	12	25	100	141	.83	.38
				140	181	1.21	.55
				180	221	1.59	.79
RRS095	1	14	28	100	151	.83	.38
				140	191	1.21	.55
				180	231	1.59	.79
RRS099	1	15	30	100	154	1.08	.49
				140	194	1.63	.74
				180	234	2.17	.98
RRS100	1	15	35	100	170	1.08	.49
				140	210	1.63	.74
				180	250	2.17	.98
RRS110	1	19	42	100	186	1.64	.74
				140	226	2.55	1.16
				180	266	3.48	1.58
RRS150	2	28	48	100	189	5.92	2.69
				140	229	9.54	4.33
				180	269	13.19	5.98
RRS190	2	28	55	100	199	8.75	3.97
				140	239	14.00	6.35
				180	277	19.26	8.74
RRS225	2	32	65	100	221	10.83	4.91
				140	261	17.49	7.93
				180	291	24.18	10.97

Note: See pages JW-7 and JW-20 for Performance Data.

Special Length L Type Hubs

Lovejoy has available special length versions of selected sizes of the L Type Jaw Coupling hubs.

Size	Standard Dimensions		Special Dimensions	
	Complete Couplings Overall Length (OAL)	Hub Length Thru Bore (LTB)	Complete Couplings Overall Length (OAL)	Hub Length Thru Bore (LTB)
L050	1.720	.62	1.10	.31
			1.34	.43
			2.24	.88
L070	2.000	.75	1.23	.38
			3.00	1.25
			3.86	1.68
L095	2.500	1.00	7.99	3.62
L100	3.500	1.375	2.37	.75
L110	4.250	1.69	2.47	.80
			6.63	2.88

- Notes:**
- For ordering information on any special length jaw hub, please contact Lovejoy Customer Service.
 - The Overall Length is calculated using two hubs with the same length thru bore.

Jaw Type



JW